

Chromalox[®]

First Name in Electric Heat
Electrical Heat Tracing Systems

Design Guide



**ROYAL ELECTRIC SUPPLY
COMPANY**

3233 W Hunting Park Avenue, Philadelphia PA 19132-1845
(800) 79-ROYAL (215) 221-1200 fax (215) 221-1201
advisors@royalelectric.com www.royalelectric.com

WE GET IT

24/7 Emergency Material Access

Chromalox®

Industrial Heat Tracing



Introduction

This design guide provides a step-by-step approach for the design, specification, and selection of a bill of materials for an electric heat tracing system. The electric heat tracing system is designed to make up for the heat lost from process system equipment through the thermal insulation. In some cases, the heat tracing system can be used for system heat-up at initial start-up or after a power shutdown.

The information contained in this guide will allow the user to design, specify and select a complete bill of materials for a pipe freeze protection or process temperature maintenance system. Information is also provided for tank freeze protection and process temperature maintenance applications. By following the steps in this guide the user can easily select a complete bill of materials for the system including: heating cable, connection accessories, and temperature controls.

Cable, Controls and Accessories

Chromalox provides a wide range of electric heat tracing cables, temperature controls and connection accessories for industrial applications. These products are designed, third party tested and approved for use in ordinary and hazardous area applications. A brief description of each product follows:

Self-Regulating

Chromalox SRL and SRM/E Self Regulating Heating Cables provide the most versatility in heat trace designs and applications. Constructed of a semiconductive heater matrix extruded between parallel buss wires, a self-regulating cable adjusts its output to independently respond to temperatures all along its length. As temperatures increase, the heater's resistance increases which lowers the output Wattage. Conversely, as the temperature decreases, the resistance decreases and the cable produces more heat. The result — an energy efficient heating cable.

Self-regulating cables are flexible, can be cut to length in the field, and can be single overlapped without fear of burnout in areas where complex piping and equipment require additional heat trace cable.

Chromalox manufactures low (SRL) and medium (SRM/E) temperature self-regulating heating cable for use on 120 and 240 Volts nominal. Available with an optional TPR or FEP jacket over the standard tinned copper braid, Chromalox self-regulating cables can meet the requirements for most corrosive or hazardous environments.

Chromalox®

Industrial Heat Tracing

Constant Wattage

Chromalox CWM Constant Wattage Heating Cables are ideally suited for applications where a particular Watt density is required at all times. The heater elements consist of a nichrome wire wrapped around parallel, insulated buss wires. At specific intervals, a short section of insulation is removed from alternating buss wires to create connection nodes for the nichrome wire. The result is a network of parallel resistors along the entire length of constant wattage cable.

Constant wattage cables are flexible, can be cut-to-length in the field, and are manufactured for use on voltages from 120 to 480V. Although not suited for overlapping, its constant output makes it an ideal choice for higher temperature applications where higher Watt densities are required. An optional FEP jacket over the standard tinned copper braid, adds additional protection for use in corrosive and hazardous areas. Contact your local Chromalox Sales office for hazardous area designs.

Mineral Insulated

Chromalox MI Mineral Insulated Heating Cables are the most rugged heating cable in the Chromalox product line. Constructed of a solid series resistor element embedded in highly compacted mineral insulation, MI cables are built to handle high temperature, high Wattage applications. The series resistor and mineral insulation are encased in a metallic jacket of Alloy 825 for high temperature or corrosive applications. Mineral insulated cables are factory assembled and tested, ensuring the highest quality product. Since the cable is assembled with a series resistor, virtually any Wattage/Voltage/length cable configuration can be produced. Chromalox MI cables are available for use in corrosive and hazardous areas. Optional accessories include pulling eyes and reverse glands. Other special features are also available.

DL-Single Point On/Off Temperature Controls

The DL Series Single Point On/Off Temperature Controls from Chromalox represent the state of the art in heat tracing accessories and are available in five models to handle a broad range of applications.

Models include two ambient sensing thermostats, two line sensing thermostats, and a line sensing solid state controller. These high-quality models combine a variety of functions in a convenient, easy to use, economical package.

DL & EL Connection System Accessories

Chromalox DL Series Connection Accessories combine molded, high strength PPS plastic enclosures with high quality stainless steel hardware for cable power connection, splice and tee connection, and cable end sealing. These liquid tight NEMA 4X rated enclosures are approved for use in both ordinary and hazardous locations. The EL series includes cast NEMA 4X and NEMA 7 enclosures for cable power connection, in both ordinary and hazardous areas. The EL series also includes convenient heat shrinkable kits for cold lead attachment, splice and tee connections, and cable end sealing. Both series provide the user a variety of functions in a convenient, easy to use, economical package.

Multi-Loop Electronic Temperature Controls

Compactly packaged, measuring only 3-3/4" deep, the 3390 Multi-Loop Controller packs the inputs, outputs, programmable features and sophisticated control techniques typically found only in much larger controllers. The 3390 Multi-Loop Controller features ten self-tuning PID control loops, universal sensor inputs (RTD, thermocouple, or scalable current), two independent alarms per loop, and one common alarm. Outputs include, relay, triac, 4-20mA, and solid state relay. RS-232, RS-422, and RS-485 digital communications are available for all ten loops and are fully compatible with ChromaSoft™ remote operator interface software. Flexible mounting options allow remote mounting, panel door mounting, or basic subpanel mounting.

Power Distribution & Temperature Control Panels

Chromalox can supply custom engineered, UL listed panels to meet most power distribution and process temperature control needs. Please contact the factory for more information.

Chromalox®

Industrial Heat Tracing System Design

This design guide is split into five sections to facilitate the heat tracing system design. The sections are: Thermal Design, Cable Selection, Electrical Design, Temperature Control Selection, and Connection Accessory Selection. We have also provided a design worksheet and bill of materials form, for your convenience.

Thermal Design

The first step in designing a heat trace system is to determine the heat loss from each pipe or tank to be traced. Collect the following data for each pipe or tank. Then follow the steps below to determine the heat loss.

Maintenance Temperature	$T_m =$	_____
Minimum Start-Up Temperature	$T_s =$	_____
Minimum Ambient Temperature	$T_a =$	_____
Nominal Pipe Size	$D_p =$	_____
Insulation Type		_____
Insulation Thickness.....		_____
Maximum Wind Speed.....		_____
Location (indoor/outdoor).....		_____
Desired Heat Loss Safety Factor		_____

To find the heat loss per foot of pipe or per square foot of tank, use the following calculations.

1. Calculate ΔT $\Delta T = T_m - T_a$

2. Find Q_p/Q_t in Table 1

For Pipes:

Find Q_p in Table 1 for the nominal pipe size and insulation thickness. Q_p is the Watts per foot per degree F heat loss from insulated metal pipes.

For Tanks:

Find Q_t in Table 1 for the insulation thickness. Q_t is the Watts per square foot per degree F heat loss from insulated metal tanks.

3. Calculate Q $Q = Q_p \times \Delta T$

Q is the Watts per foot heat loss of the pipe or watts per square foot heat loss of the tank given the temperature you wish to maintain, the minimum ambient temperature, pipe size, and insulation thickness.

4. Adjust Q for Deviations

Adjustments to the heat loss are necessary due to insulation efficiency (K factor), wind speed, and location (indoor/outdoor).

A. Insulation K Factor $Q = Q \times 2 (K_{Tm} + K_{Ta})$
 K_{Tm} is the K factor of the insulation at the maintenance temperature.

K_{Ta} is the K factor of the insulation at the ambient temperature. These values are found in Table 2. Choose the K factor equal to or below the required temperature.

B. Wind Speed $Q = Q \times \text{Percent}$

Table 1 is based on wind speeds of 20 MPH. Add 5% additional safety margin for each 5 MPH over 20 MPH. The maximum safety margin is 10% for wind speed.

C. Location

Multiply Q by 0.9, if the installation is located indoors.

D. Additional Safety Factors

Multiply Q by any additional safety factors required by the specifications.

5. Calculate Total Heat Loss of the Tank

(Skip to step 6 for Pipes)

For tanks it is necessary to convert the Watts per square foot heat loss (Q value from step 4) to a total heat loss for the tank.

A. Calculate Tank Surface Area

For Cylindrical Tanks, Surface Area =

$$SA = 2\pi r^2 + \pi DH$$

= $\pi D(r+H)$, where r is the tank radius, D is the tank diameter and H is the tank height.

For Rectangular Tanks, Surface Area =

$$SA = 2[(W*L)+(L*H)+(H*W)],$$
 where L is the tank length, W is the tank width and H is the tank height.

B. Calculate Total Heat Loss

Multiply the tank surface area from step 5A by the Watts per square foot heat loss from step 4 to determine the total heat loss in Watts for the tank.

$$W = SA * Q$$

6. Completed Heat Loss Calculation

Q is now equal to the Watts per foot heat loss of the pipe. W is now equal to the total heat loss, in Watts, of the tank. These heat loss values are corrected for insulation K factor, wind speed, location and any other additional safety factors required by the specifications. Continue to calculate heat losses for additional pipes or tanks in the system. Use the design worksheet provided to track data from each pipe or tank. When Q or W values have been calculated for each pipe or tank, continue to the Cable Selection section of this guide.

Chromalox®

Industrial Heat Tracing System Design

Table 1 — Heat Losses from Insulated Metal Pipes
W/Ft. of Pipe per °F Temperature Differential

Pipe Size (IPS)	Insulation Thickness (In.)							
	1/2	3/4	1	1-1/2	2	2-1/2	3	4
1/2	0.054	0.041	0.035	0.028	0.024	0.022	0.020	0.018
3/4	0.063	0.048	0.040	0.031	0.027	0.024	0.022	0.020
1	0.075	0.055	0.046	0.036	0.030	0.027	0.025	0.022
1-1/4	0.090	0.066	0.053	0.041	0.034	0.030	0.028	0.024
1-1/2	0.104	0.075	0.061	0.046	0.038	0.034	0.030	0.026
2	0.120	0.086	0.069	0.052	0.043	0.037	0.033	0.029
2-1/2	0.141	0.101	0.080	0.059	0.048	0.042	0.037	0.032
3	0.168	0.118	0.093	0.068	0.055	0.048	0.042	0.035
3-1/2	0.189	0.133	0.104	0.075	0.061	0.052	0.046	0.038
4	0.210	0.147	0.115	0.083	0.066	0.056	0.050	0.041
4-1/2	0.231	0.161	0.125	0.090	0.072	0.061	0.054	0.044
5	0.255	0.177	0.137	0.098	0.078	0.066	0.058	0.047
6	0.300	0.207	0.160	0.113	0.089	0.075	0.065	0.053
7	0.342	0.235	0.181	0.127	0.100	0.084	0.073	0.059
8	0.385	0.263	0.202	0.141	0.111	0.092	0.080	0.064
9	0.427	0.291	0.222	0.156	0.121	0.101	0.087	0.070
10	0.474	0.323	0.247	0.171	0.133	0.110	0.095	0.076
12	0.559	0.379	0.290	0.200	0.155	0.128	0.109	0.087
14	0.612	0.415	0.316	0.217	0.168	0.140	0.118	0.093
16	0.696	0.471	0.358	0.246	0.189	0.155	0.133	0.104
18	0.781	0.527	0.401	0.274	0.210	0.172	0.147	0.115
20	0.865	0.584	0.443	0.302	0.231	0.189	0.161	0.125
24	1.034	0.696	0.527	0.358	0.274	0.226	0.189	0.147
Tank	0.161	0.107	0.081	0.054	0.040	0.032	0.027	0.020

Values in Table 1 are based on the following formulas plus 10% safety margin. The K factor of 0.25 for Fiberglass® at 50°F is assumed.

Watts/Ft. of pipe = $2 \pi k (\Delta T) \div (Z \ln. (D_o/D_i))$
 where K = Thermal conductivity
 BTU x In./Hr. x Ft² x °F
 D_o = Outside diameter of insulation (In.)
 D_i = Inside diameter of insulation (In.)
 ΔT = Temperature differential (°F)
 Z = 40.944 BTU x In./W x Hr. x Ft.

Watts/Sq. Ft. = $Y k (\Delta T) \div X$
 where K = Thermal conductivity
 (BTU x In./Hr. x Ft² x °F)
 X = Thickness of insulation (In.)
 Y = 0.293 W x Hr./BTU

Table 2 — K Factor Chart for Various Insulation Types*

Temperature (°F)	0	50	100	150	200	250	300	350	400
Fiberglass	0.23	0.25	0.27	0.29	0.32	0.34	0.37	0.39	0.41
Calcium Silicate	0.35	0.37	0.40	0.43	0.45	0.47	0.50	0.53	0.55
Urethane	0.18	0.17	0.18	0.22	0.25	—	—	—	—
Cellular Glass	0.38	0.40	0.46	0.50	0.55	0.58	0.61	0.65	0.70

*Select the K factor equal to or below the maintenance temperature for K_{Tm} or the K factor equal to or below the ambient temperature for K_{Ta}.

Pipe Example:

T_m = 100°F
 T_s = 40°F
 T_a = 0°F
 Pipe Size = 2 inches
 Insulation = Fiberglass®
 Thickness = 1 inch
 Wind speed = 20 MPH
 Location = Outdoor
 H.L.S.F. = 10%

- ΔT = 100°F - 0°F = 100°F
- Q_p = 0.069 W/(Ft. °F)
- Q = (0.069) x 100
- A. Q = 6.90 x 2 x (0.27 + 0.23)
 B. Table 1 based on 20 MPH wind. No additional heat loss.
 C. Location is outdoors.
 D. Table 1 includes a 10% safety factor.

Results: Q = 6.90 W/Ft.

Tank Example:

Maintain a metal tank with 2 inches of Fiberglass® insulation at 50°F. The tank is cylindrical and is 4 feet in diameter and 12 feet long. The minimum ambient temperature is 0°F and the maximum expected wind speed is 15 MPH.

- ΔT = 50°F - 0°F = 50°F
- Q_t = 0.040 W/Ft² x °F
- Q = (0.040) x (50) = 2.0 W/Ft²
- A. Q = (2.0 x 2) x (0.25 + 0.23) = 1.92 W/Ft²
 B. No Adjustments
 C. No Adjustments
 D. No Adjustments
- A. Surface area (SA) = π x 4 x (2 + 12) = 175.9 Ft²
 B. W = 175.9 Ft² x 1.92 W/Ft² = 337.7 Watts

Chromalox®

Industrial Heat Tracing System Design

Cable Selection

The second step in heat trace system design is to select the correct cable for your pipe or tank application. Collect the following data for each pipe or tank. Then, follow the steps below to select the correct cable for your application.

Maintenance Temperature = _____
 Maximum Exposure Temperature = _____
 Heat Requirement (Q or W from Thermal Design section) = _____
 Pipe Material (Metal or Plastic) = _____
 Supply Voltage = _____
 Potential Chemicals Exposed to Cable (Organic, In-Organic, Corrosives) = _____
 Area Classification = _____
 Temperature Class = _____

1. Select Cable Type

Compare the maximum maintenance temperature and maximum exposure temperature with temperatures listed in the Cable Selection Table below. Both maximum maintenance and maximum exposure temperatures in your system must be below the values listed in the table for the cable type selected. Please see the Mineral Insulated Cable design section if selecting Mineral Insulated Cable.

When heat tracing plastic pipes or tanks, use only SRL Self-Regulating Low-Temperature cable. Skip to section 4, SRL Self-Regulating Low-Temperature Cable Output for Plastic Pipes or Tanks to determine the cable output rating.

Table 3 — Temperature Ratings

Heating Cable	Max. Maint. Temp.	Max. Exposure Temp. (Power Off)
Self-Regulating		
Low	150°F	185°F
Medium	250°F	375°F
Constant Wattage	356°F	392°F
Mineral Insulated		
INCOLOY® Alloy 825 Sheath	900°F	1100°F

Table 4 — Constant Wattage Maximum Maintenance Temperatures

Output (W/Ft.)	2.0	2.3	2.5	3	4	6	6.7	8	9	10.1	10.6	12	13.4	16
w/o														
Al. Tape	356	351	348	340	325	293	282	262	246	229	222	200	178	137
w/														
Al. Tape	356	355	353	360	344	332	328	320	314	307	304	296	286	272

Chromalox®

Industrial Heat Tracing

System Design

2. Determine Required Jacket Material

Select the appropriate jacket configuration for the desired level of mechanical and corrosive chemical protection. All Constant Wattage and Self-Regulating cables are supplied with a tinned copper grounding braid. The tinned copper braid provides a ground path to be used with Equipment Protection Device (EPD) ground fault circuit breakers. The National Electrical Code (NEC) requires the use of ground fault circuit breakers for all heating cable installations. Chromalox recommends the use of 30 mA trip Equipment Protection Device (EPD) ground fault breakers. The CR over-jacket option can be used when additional mechanical protection is desired. The CR over-jacket option is required when the cable can be exposed to aqueous inorganic chemicals. The CT over-jacket option is required when the cable can be exposed to organic chemicals or strong corrosives. Use Table 5 to determine the correct jacket material option for the cable type selected.

Table 5 — Corrosion Guide to Select the Proper Cable Construction

Exposure to	SRL	SRM	CWM	INCOLOY® MI
Moisture	C, CR, CT	C, CT	C, CT	Acceptable
Aqueous Solutions of Inorganic Compounds	CR, CT	CT	CT	Acceptable
Liquid Organic Chemicals	CT	CT	CT	Acceptable
Acids or Bases	CT	CT	CT	Acceptable

3. Select Cable Output Rating

Select the appropriate heat output for the cable type selected in step one. For all Cables, the Watts per foot output selected should be higher than the calculated Watts per foot heat loss of the pipe or tank. For Constant Wattage cable, simply select the cable output that most closely exceeds the calculated heat loss. For Mineral Insulated cable, please see page 19 to design the proper output assembly. For Self-Regulating cable, use the graphs that follow to determine the Watts per foot output of the cable at the pipe or tank maintenance temperature, then select the output rating that most closely exceeds the calculated heat loss. (See example for self-regulating cables.)

In some instances the calculated heat loss may exceed the output rating of the selected cable. Should this happen, there are a number of solutions:

- A. Choose a different type of cable.
- B. Recalculate heat loss with thicker insulation.
- C. Select an insulation with a lower K factor.
- D. Use two or more parallel runs of cable, where the sum of the cables output exceeds the calculated heat loss.
- E. Spiral wrap a single run of cable. Divide the Pipe Heat Loss by the Cable Output. This is equal to the number of feet of cable needed for every 1 foot of pipe length. (See Table 9 for details on spiral wrapping.) As bending the heating cables can cause damage, it is recommended to use multiple straight runs of heat trace instead of spiral wrapping. Straight runs of cable also facilitate installation significantly.

Chromalox[®]

Industrial Heat Tracing System Design

Self-Regulating Cable Output Selection Example

Locate the graph for the selected cable, in our case we select the SRM/E cable. For our example assume a heat loss of 9.5 Watts/Ft. Locate the desired pipe maintenance temperature along the x-axis in the graph. In our case we wish to maintain 150°F. From the desired maintenance temperature, draw a vertical line perpendicular to the x-axis through the cable output lines. Select the cable output that exceeds the calculated heat loss at the intersection of the output and maintenance temperature lines for our example we choose a 15 Watt cable because the cable output (10 Watts/Ft. @ 150°F) exceeds the calculated 9.5 Watts/Ft. heat loss).

Self-Regulating Cable Output Selection

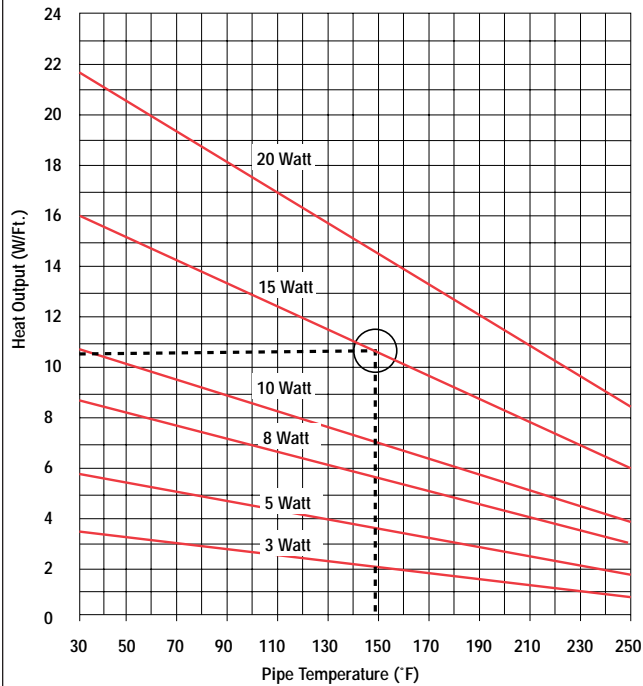

Graph 1 — SRL Cable Output
Thermal Output Ratings on Insulated
Metal Pipe

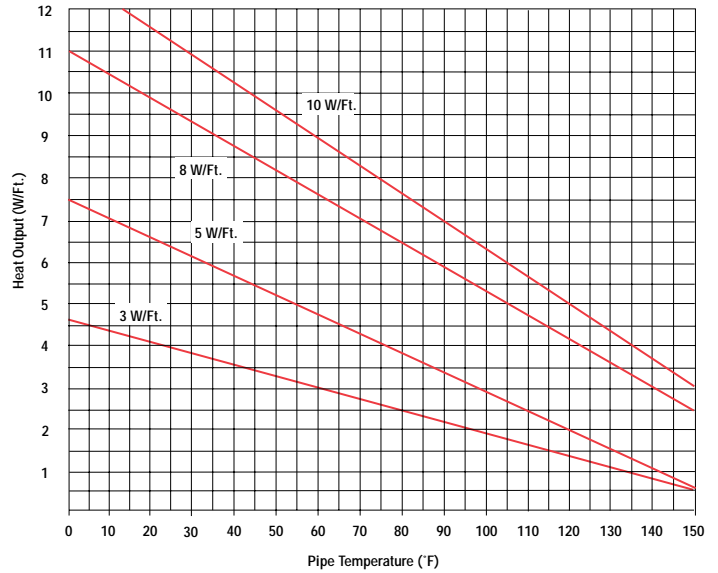

Graph 2 — SRM/E Cable Output
Thermal Output Ratings On Insulated
Metal Pipe

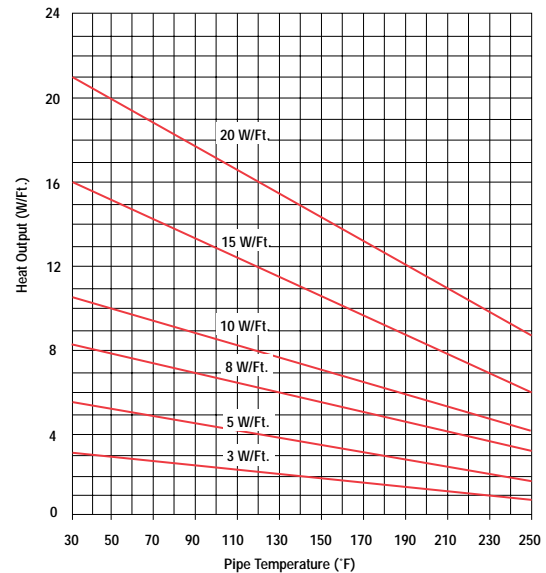

Chromalox®

Industrial Heat Tracing System Design

4. SRL Self-Regulating Low Temperature Cable Output for Plastic Pipes or Tanks

If the pipe or tank material is metal, no adjustments to cable output are necessary. If the pipe material is plastic, the heat transfer characteristics of the Self-Regulating Low Temperature (SRL) cable change. The SRL cable is the only cable Chromalox supplies that is third party approved for use on plastic pipes. Chromalox does not recommend use of any other cable products for plastic pipe protection. If another cable product has been selected, return to step 1 of this section and select all cable parameters based on the SRL cable type.

The SRL cables are well suited for use on plastic pipe. The self-regulating characteristic maintains the maximum temperature of the cable to acceptable limits for most plastic pipe applications. Ensure that the maximum allowable temperature, for the piping used, exceeds the T-rating (see Table 8) of the SRL cable selected. The SRL cable must be installed using aluminum tape. The aluminum tape is installed over the entire length of the cable. Use Graph 3 to determine cable heat output when using this installation method. If improved heat transfer is desired, a run of aluminum tape can be placed on the pipe under the cable and then again over the entire cable length. Use Graph 4 to determine cable heat output when using this installation method.

Graph 3 — SRL on Plastic Pipes with Aluminum Tape Over Cable

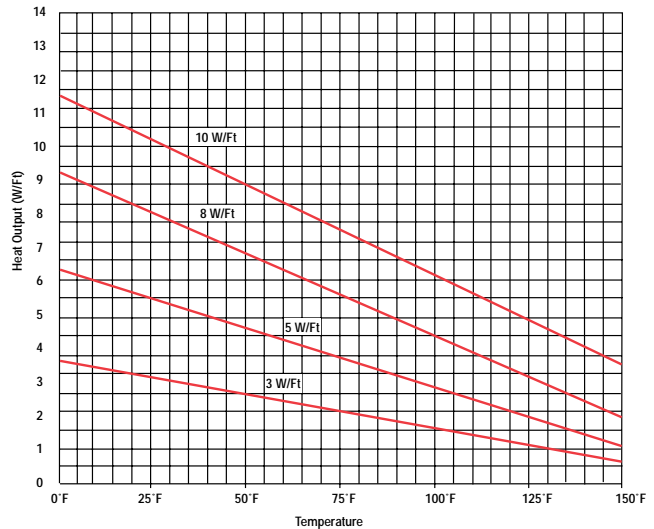

Graph 4 — SRL on Plastic Pipes with Aluminum Tape Under and Over Cable

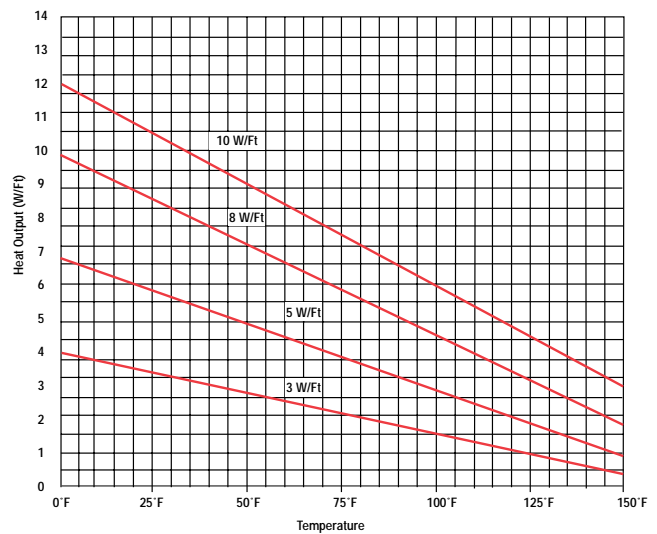

Chromalox®

Industrial Heat Tracing System Design

5. Adjust Cable Output for Supply Voltage

In some instances it may be necessary to adjust the cable output due to differences in supply Voltage. All cable ratings shown in this guide are based on nominal supply voltage. For Constant Wattage cable, use Table 6 to rate the cable output, if other than nominal supply Voltage is used. For Self-Regulating cable, use Table 7 and multiply the selected cable output from step 2 by the appropriate scaling factor from the table, if other than nominal supply Voltage is used.

Table 6 — Output Wattage Table for Various Operating Voltages for CWM Cable

Type		120V	208V	220V	240V	277V	480V
CWM	12-1	12.0	—	—	—	—	—
	8-1	8.0	—	—	—	—	—
	4-1	4.0	12.0	13.4	16.0	—	—
	12-2	3.0	9.0	10.1	12.0	16.0	—
	8-2	2.0	6.0	6.7	8.0	10.6	—
	12-4	—	2.3	2.5	3.0	4.0	12.0

Table 7 — Output Derating Table for Alternate Voltages for SRL and SRM Cables

Type	Rating	208V	220V	277V
SRL	3-2	80%	87%	115%
	5-2	82%	90%	113%
	8-2	86%	91%	112%
	10-2	87%	92%	110%
SRM/E	3-2	78%	86%	124%
	5-2	79%	87%	123%
	8-2	81%	88%	123%
	10-2	81%	88%	122%
	15-2	85%	90%	123%
	20-2	88%	92%	122%

6. Area Classification

Please see the Chromalox Cable Approval Guide (PJ709) for hazardous area acceptability and third party approval information for the cable selected. Ensure that the cable selected is suitable for the area classification. Consult the factory for Class 1 Division 1 installations. Use Table 8 for self-regulating cable to determine if the T-Rating for the cable selected is acceptable for use per area classification guidelines. The T-ratings shown in Table 8 are based on the product classification approach method as indicated in IEEE Std. 515-1997. Please consult the factory if your application requires a T-rating different from those shown in Table 8. Constant Wattage and

Mineral Insulated cables must be designed such that the cable sheath temperature does not exceed the auto ignition temperature. Please consult the factory for hazardous area designs that employ Constant Wattage or Mineral Insulated cables.

Table 8 — Self Regulating Cable T-Ratings

Type	Rating	T-Rating	Max. Temp.
SRL	3-1, 3-2	T6	185°F
	5-1, 5-2	T5	212°F
	8-1, 8-2	T5	212°F
	10-1, 10-2	T4A	248°F
SRM/E	3-1, 3-2	T3	392°F
	5-1, 5-2	T3	392°F
	8-1, 8-2	T3	392°F
	10-1, 10-2	T2D	419°F
	15-1, 15-2	T2D	419°F
	20-1, 20-2	T2D	419°F

7. Specifying the Heating Cable Product

Use the codes below to construct the cable model number. Once the model number is constructed, consult the appropriate cable product data sheet to determine the PCN number to order the cable.

For Self Regulating cable, state the length followed by: SRab-cdef
 where **a** is the temperature rating and is denoted as L for low temp. and M for medium temp.
b is the Wattage per foot — 3, 5, 8, 10, 15 or 20 Watts per foot
c is the supply Voltage — 1 for 120, 2 for 208-277 Volt.
d is "M" if monitor wire is required.
e is "C" to designate tinned copper overbraid
f is "CR" if an overbraid and TPR jacket is required (not available in SRM/E cable), or "CT" if an overbraid and fluoropolymer jacket is required.

For Constant Wattage cable, state the length followed by: CWMa-bcd
 where **a** is the Wattage per foot — 4, 8 or 12 watts per foot.
b is the supply Voltage — 1 for 120, 2 for 208-277, and 4 for 480 Volt.
c is "C" to designate tinned copper overbraid
d is "CT" if an overbraid and fluoropolymer jacket is required.

Chromalox®

Industrial Heat Tracing System Design

8. Determine the Total Cable Length

For Pipes:

In addition to the system piping, in-line equipment such as valves, flanges and pipe supports require additional heat tracing to maintain the system operating temperatures.

Total feet of traced pipe + Cable allowance for components = Total cable length.

Note — If spiral wrapping, multiply the total feet of pipe to be traced by the heat loss (Q) and divide the result by the cable output rating. Substitute this value for the total feet of pipe to be traced in the equation above. If using multiple runs of cable on

the same pipe, multiply the total length of pipe to be traced by the number of runs used, and substitute this result for the total feet of pipe to be traced in the equation above.

For Tanks:

To determine the total length of cable required for tank tracing, divide the total heat loss of the tank in Watts per square foot (W from Thermal Design section step 5B) by the output in Watts per foot at the maintenance temperature of the cable selected.

Total Cable Length = W/cable output at maintenance temperature.

Component Cable Allowances

Component	Cable Allowance (Ft.)		# of Components		Total Additional Cable
Flange Pair	1.5	x	_____	=	_____
Pipe Support	2.0	x	_____	=	_____
Butterfly Valve	2.5	x	_____	=	_____
Ball Valve	2.7	x	_____	=	_____
Globe Valve	4.0	x	_____	=	_____
Gate Valve	5.0	x	_____	=	_____

Table 9 — Wrapping Factor (Feet of Cable per Foot of Pipe)

Pipe Size	Pitch (In.)																	
	2	3	4	5	6	7	8	9	10	11	12	14	16	18	24	30	36	42
1/2	1.90	1.47	1.29	1.19	1.14	1.10	1.08	1.06	—	—	—	—	—	—	—	—	—	—
3/4	2.19	1.64	1.40	1.27	1.19	1.14	1.11	1.09	1.07	1.06	—	—	—	—	—	—	—	—
1	2.57	1.87	1.55	1.38	1.27	1.21	1.16	1.13	1.11	1.09	1.07	—	—	—	—	—	—	—
1-1/4	3.07	2.18	1.76	1.53	1.39	1.30	1.24	1.19	1.16	1.13	1.11	1.08	1.06	—	—	—	—	—
1-1/2	3.43	2.41	1.92	1.65	1.48	1.37	1.29	1.24	1.20	1.16	1.14	1.10	1.08	1.06	—	—	—	—
2	4.15	2.86	2.25	1.90	1.67	1.52	1.42	1.34	1.28	1.24	1.20	1.15	1.12	1.10	1.05	—	—	—
2-1/2	4.91	3.36	2.61	2.17	1.89	1.70	1.56	1.46	1.39	1.33	1.28	1.21	1.17	1.13	1.08	1.05	—	—
3	5.88	3.99	3.06	2.52	2.17	1.93	1.76	1.63	1.53	1.45	1.39	1.30	1.23	1.19	1.11	1.07	1.05	—
4	7.43	5.01	3.82	3.11	2.65	2.33	2.09	1.92	1.78	1.67	1.58	1.45	1.36	1.29	1.17	1.11	1.08	1.06
5	9.09	6.10	4.63	3.75	3.17	2.77	2.47	2.24	2.06	1.92	1.81	1.63	1.51	1.42	1.25	1.17	1.12	1.09
6	10.75	7.20	5.44	4.40	3.70	3.22	2.86	2.58	2.36	2.19	2.04	1.83	1.67	1.55	1.34	1.23	1.16	1.12
8	13.88	9.28	6.99	5.63	4.72	4.08	3.60	3.23	2.94	2.71	2.51	2.22	2.00	1.83	1.53	1.36	1.26	1.20
10	17.20	11.49	8.65	6.94	5.81	5.01	4.41	3.95	3.58	3.28	3.03	2.65	2.37	2.15	1.75	1.52	1.38	1.29
12	20.34	13.58	10.21	8.19	6.85	5.89	5.18	4.62	4.18	3.83	3.53	3.07	2.73	2.40	1.97	1.68	1.51	1.39
14	22.30	14.89	11.18	8.97	7.49	6.44	5.66	5.05	4.57	4.17	3.85	3.34	2.96	2.67	2.11	1.79	1.59	1.46
16	25.44	16.98	12.75	10.22	8.53	7.33	6.43	5.74	5.18	4.73	4.35	3.77	3.33	3.00	2.34	1.97	1.73	1.57
18	28.58	19.07	14.31	11.47	9.57	8.22	7.21	6.42	5.80	5.29	4.86	4.20	3.71	3.33	2.58	2.15	1.88	1.69
20	31.71	21.16	15.88	12.72	10.61	9.11	7.99	7.11	6.42	5.85	5.38	4.64	4.09	3.66	2.82	2.34	2.03	1.81
24	37.99	25.34	19.02	15.22	12.70	10.90	9.55	8.50	7.66	6.98	6.41	5.52	4.85	4.34	3.32	2.72	2.33	2.07

Note — To determine the wrapping factor, divide the calculated heat loss by the heat output of the cable. Locate the value that is equal to or the next highest in the row for the pipe size in your application. The value at the top of the column is the pitch or spacing from center to center of the cable along the pipe.

CAUTION: When spiral wrapping pipe, please note that the minimum bending radius for all cables equals six times the minor diameter of the cable. Not all cables are suitable for spiral wrapping small diameter pipes. Cable can be damaged if the minimum bending radius is not observed.

Chromalox®

Industrial Heat Tracing System Design

Electrical Design

The next step in heat trace system design is to size circuit breakers for circuit protection. The National Electrical Code (NEC 1996) requires the use of ground fault style breakers for heating cable circuit protection. Chromalox recommends use of thermal magnetic style circuit breakers with a ground fault trip set at 30mA (equipment protection device) to eliminate nuisance tripping at low temperatures that can occur with magnetic type or lower rated ground fault trip breakers. To determine the number of circuits required, collect the information below:

- Minimum Start-Up Temperature
- Available Circuit Breaker Rating
- Total Cable Length for each Pipe or Tank.

Constant Wattage Cable

To determine the correct circuit breaker rating, find the model number of the cable selected in Table 10. Multiply the total cable length for each pipe or tank by the circuit load (Amps/ft.) for the cable selected. Multiply the result by 1.25. This result is the total current draw for the circuit plus a 25% safety factor as required by the National Electrical Code Article 384-16(c). Ensure that the circuit breaker rating selected exceeds the 25% safety factor adjusted current draw. Step-up to the next breaker size if the rating does not exceed the safety factor adjusted current draw.

Total circuit current draw = circuit load (Amps/ft.) * total cable length for the pipe

Safety Factor adjusted current draw = Total circuit current draw * 1.25

To determine the number of circuits required for each pipe or tank, divide the total cable length by the maximum circuit length shown in Table 10 for the cable selected. Round the result to the next higher number.

Number of Circuits = $\frac{\text{Total Cable Length}}{\text{Maximum Circuit Length}}$

Mineral Insulated Cable

To determine the correct circuit breaker rating, find the total current draw for each circuit. Divide the total cable wattage by the operating voltage. Multiply this result by

1.25. This result is the total current draw for the circuit plus the 25% safety factor required by National Electrical Code Article 384-16(c). Ensure that the breaker rating selected exceeds the safety factor adjusted current draw.

Total circuit current draw = Total Cable Wattage/Operating Voltage

Safety Factor adjusted current draw = Total circuit current draw * 1.25

Self Regulating Cable

Table 10 contains maximum circuit lengths by cable type, minimum start-up temperature, and circuit breaker rating. If the circuit breaker rating is pre-determined use the maximum circuit length shown in the table for the cable type, minimum start-up temperature, and breaker rating to determine the number of circuits required. Divide the total cable length by the maximum circuit length for the selected cable, minimum start-up temperature, and breaker rating.

Number of Circuits = $\frac{\text{Total Cable Length}}{\text{Maximum Circuit Length}}$

If the circuit breaker rating has not been determined, use Table 10 and find the cable type and minimum start-up temperature. Compare the maximum circuit length for each breaker rating to the total cable length required for each pipe or tank. Select the breaker rating whose maximum circuit length just exceeds the total cable required for the pipe or tank. The breaker sizing and maximum circuit lengths shown in Table 10 take into account in-rush current characteristics as well as National Electrical Code required safety factors.

Circuit Breaker Selection

Chromalox recommends use of thermal magnetic circuit breakers. Use of thermal magnetic breakers minimizes the possibility of nuisance tripping at low temperature that can occur with use of magnetic circuit breakers. The National Electrical Code requires the use of ground fault protection for all heating cable installations. Chromalox recommends use of 30mA trip Equipment Protection Device (EPD) ground fault breakers.

Chromalox®

Industrial Heat Tracing System Design

Table 10 — Maximum Circuit Lengths

CWM Maximum Circuit Lengths

Model	Output (W/Ft.)	Voltage (Vac)	Circuit Load (Amps/Ft.)	Max. Circuit Length (Ft.)	Module Length (Ft.)
CWM4-1C(T)	4	120	0.033	350	2.5
CWM8-1C(T)	8	120	0.067	240	2.5
CWM12-1C(T)	12	120	0.100	200	2.5
CWM4-2C(T)	4	240	0.017	700	2.5
CWM8-2C(T)	8	240	0.033	480	2.5
CWM12-2C(T)	12	240	0.050	400	2.5
CWM12-4C(T)	12	480	0.025	780	2.5

SRL Maximum Circuit Lengths (Ft.)

Cable Rating	50°F Start-Up				0°F Start-Up				-20°F Start-Up			
	15A	20A	30A	40A	15A	20A	30A	40A	15A	20A	30A	40A
SRL3-1C, CR, CT	305	360	NR	NR	200	270	360	NR	185	245	360	NR
SRL3-2C, CR, CT	600	660	NR	NR	415	555	660	NR	370	495	660	NR
SRL5-1C, CR, CT	185	250	270	NR	135	180	270	NR	120	160	245	270
SRL5-2C, CR, CT	375	505	540	NR	270	360	540	NR	245	325	490	540
SRL8-1C, CR, CT	150	200	215	NR	110	145	215	NR	100	130	200	210
SRL8-2C, CR, CT	285	375	420	420	200	265	395	420	175	235	350	420
SRL10-1C, CR, CT	95	130	180	NR	80	105	155	180	70	95	140	180
SRL10-2C, CR, CT	160	210	315	360	125	170	255	340	120	160	240	320

SRM/E Maximum Circuit Lengths (Ft.)

Cable Rating	50°F Start-Up					0°F Start-Up					-20°F Start-Up				
	15A	20A	30A	40A	50A	15A	20A	30A	40A	50A	15A	20A	30A	40A	50A
SRM/E 3-1C(T)	285	385	NR	NR	NR	275	375	385	NR	NR	265	365	385	NR	NR
SRM/E 3-2C(T)	575	770	780	NR	NR	540	750	780	NR	NR	525	740	780	NR	NR
SRM/E 5-1C(T)	180	240	360	375	NR	165	220	330	375	NR	155	210	310	375	NR
SRM/E 5-2C(T)	360	480	720	750	NR	325	430	645	750	NR	310	415	620	750	NR
SRM/E 8-1C(T)	145	190	285	325	NR	135	175	265	325	NR	130	165	250	325	NR
SRM/E 8-2C(T)	285	380	575	650	NR	255	345	520	650	NR	245	335	490	650	NR
SRM/E 10-1C(T)	95	125	190	250	NR	90	110	175	250	NR	85	100	170	245	NR
SRM/E 10-2C(T)	190	255	385	490	NR	165	225	345	490	NR	155	215	330	470	NR
SRM/E 15-1C(T)	70	95	145	190	210	65	85	125	165	210	60	80	120	150	210
SRM/E 15-2C(T)	145	190	290	385	420	120	175	270	360	420	115	165	260	340	420
SRM/E 20-1C(T)	60	75	115	155	160	50	65	105	140	160	45	65	100	135	160
SRM/E 20-2C(T)	115	155	230	305	350	100	135	200	270	350	90	130	195	255	335

*Thermal magnetic circuit breakers are recommended since magnetic circuit breakers could “nuisance trip” at low temperature. NR = Not Required, maximum circuit length has been reached in a smaller breaker size.

Chromalox®

Industrial Heat Tracing System Design

Temperature Control Selection

Typical heat trace installation temperature control is accomplished by one of two methods, Ambient Air Sensing or Pipe Wall Sensing. When designing a heat trace system with relatively few circuits, temperature control can be accomplished using single point on/off controls. When designing a heat trace system with a large number of circuits, or a system that protects critical plant functions, it is often advantageous to use central control panels that employ electronic control. Chromalox provides products for both large and small system needs.

Ambient Air Sensing Control

Ambient Air Sensing Control is often used in freeze protection applications. It can also be used in process maintenance applications if the process can tolerate large temperature variations. In an ambient air sense control system, a thermostat is used to sense ambient air and switch the heating cable on and off at a preset ambient temperature. For a small number of circuits, single point thermostats can be used to switch individual circuits on and off. If a large number of circuits is involved, a single strategically located thermostat can be used in conjunction with a contactor to switch all circuits on or off at the preset air temperature. A centralized panel board and electronic circuit monitoring system are often used for control of large numbers of circuits. The schematic below depicts a typical ambient sensing circuit.

Ambient Air Sensing (Single Circuit)

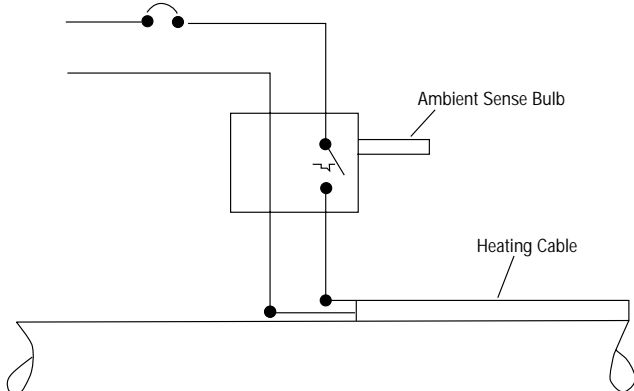

Pipe Wall Sensing Control

Pipe wall sensing control is used for process maintenance applications where the process temperature must be controlled within a moderate or narrow band. In a pipe wall sensing control system, a thermostat or RTD is used to sense pipe wall temperature and switch the heating cable on and off at a preset temperature. For a small number of circuits, single point thermostats can be used to switch individual circuits on and off. If a large number of circuits is involved, a centralized panel board and electronic circuit monitoring system is often used. The schematics below depict typical pipe wall sensing circuits.

Pipe Wall Sensing (Single Circuit)

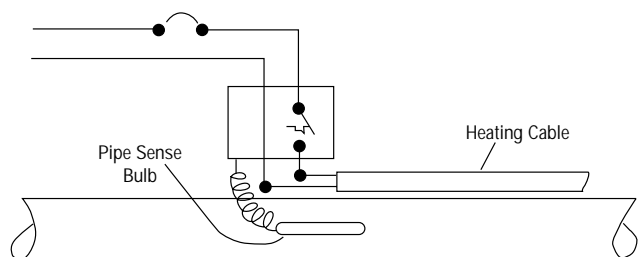

Monitor and Control Panel (Multi-Circuit)

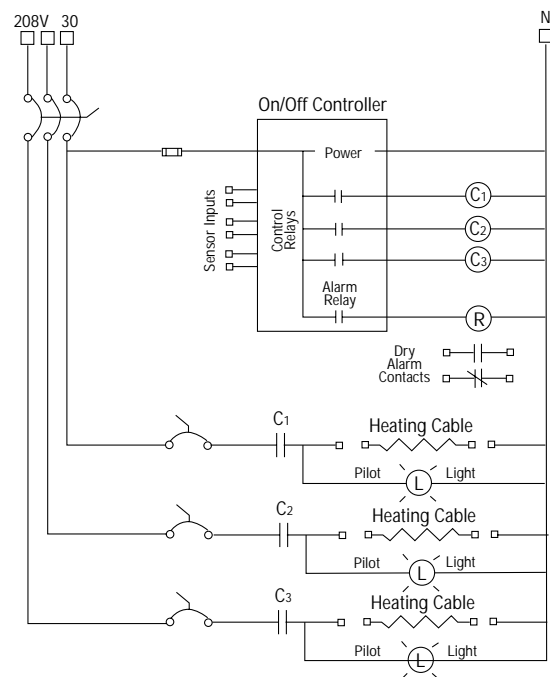

Chromalox®

Industrial Heat Tracing System Design

Temperature Control Selection *Single Point On/Off Controls*

Use Table 11 and Table 12 to select the proper thermostat control device for your application. Select the control device that meets installation needs for operating voltage, switching current, setpoint range, ambient sense or pipe sense control, operating environment and area classification. If your circuit current exceeds the switch current of the device selected, use the device in conjunction with a contactor suitable for your circuit current. Use Table 13 to select grommets needed for sealing cable entries.



Table 11 — DL Series Temperature Controls - Specifications

Designation	Control Type	Used With	Operating Voltage	Switch Rating (Amps)	Set Point Range	Factory Preset	Operating Temp. Range	Max. Sensor Exposure Temp.	Sensor
RTAS	Ambient Sense	SRL, SRM/E, CWM	120-480	22	0°-225°F	40°F	-40°-160°F	450°F	9/16" OD x 3" L Stainless Steel Probe
RTAS-EP	Ambient Sense	SRL, SRM/E, CWM	120-250	11	0°-225°F	40°F	-40°-160°F	450°F	9/16" OD x 3" L Stainless Steel Probe
RTBC	Pipe Wall Sense Bulb and Capillary	SRL, SRM/E, CWM	120-480	22	0°-400°F	200°F	-40°-160°F	450°F	1/4" OD x 7-1/4" L Stainless Steel Bulb 3' SS Capillary
RTBC-EP	Pipe Wall Sense Bulb and Capillary	SRL, SRM/E, CWM	120-250	11	0°-400°F	200°F	-40°-160°F	450°F	1/4" OD x 7-1/4" L Stainless Steel Bulb 3' SS Capillary
RTSS	Pipe Wall Sense RTD	SRL, SRM/E, CWM	120-240	20	Type A = 0°-100°F Type B = 50°-250°F Type C = 200°-600°F	N/A N/A N/A	0°-150°F	450°F	1/4" OD x 4" L Ohm RTD 3' Teflon Leads

Table 12 — DL Series Temperature Controls - Area Classifications

Designation	Third Party Approvals		
	UL	CSA	FM
RTAS	Ordinary Areas	Ordinary Areas	Ordinary Areas
RTAS-EP	Ordinary Areas	Ordinary Areas Class I, Div. 2 Groups A,B,C,D Class II, Div. 2 Groups F,G	Ordinary Areas Class I, Div. 2 Groups B,C,D Class II, Div. 2 Groups F,G Class III, Div. 2 Areas
RTBC	Ordinary Areas	Ordinary Areas	Ordinary Areas
RTBC-EP	Ordinary Areas	Ordinary Areas Class I, Div. 2 Groups A,B,C,D Class II, Div. 2 Groups F,G	Ordinary Areas Class I, Div. 2 Groups B,C,D Class II, Div. 2 Groups F,G Class III, Div. 2 Areas
RTSS	Not applied For	Not Applied For	Not Applied For

Table 13 — DL Series Grommet Selection

Grommet Designation	Used With
GR1	SRL-C
GR2	SRL-CR, CT
GR3	CWM-C
GR4	CWM-CT
GR5	SRL-MC
GR6	SRL-MCR, MCT
GR7	SRM/E-C
GR8	SRM/E-CT

Chromalox®

Industrial Heat Tracing System Design

Temperature Control Selection:

Multi Circuit Temperature Control Panels

Chromalox has the capability to provide UL listed temperature control panels tailored to the requirements of most any application or specification. These panels are typically grouped into two types, ambient sensing or pipe wall sensing control. Contact the factory for control panel design assistance.

The 3390 ten channel temperature control lies at the heart of each of these panels. The 3390 features: On/Off or PID temperature control. Universal sensor inputs. Relay, triac, 4-20mA, or solid state relay control outputs. Alarms are provided for high and low temperature, as well as sensor failure.

The 3390 user is also capable of remote monitoring of the heat trace system through RS-232, RS-422, and RS-485 digital communications and ChromaSoft™ Remote Operator Interface Software.

Ambient Sense Panels

Ambient sense panels typically rely on a single temperature sensor and control to activate all of the power control devices. Typical ambient sense panels contain:

1. Ambient Sense Thermostat driving a single large contactor or a 3390 series control driving a number of individual circuit contactors or solid state relays.
2. Pilot Light for Power On indication.

3. Manual Disconnect Switch.
4. Cooling Fan.
5. Individual Ground Fault Circuit Breakers.
6. NEMA 4X, 7 and 12 enclosures available.
7. Optional current monitoring.
8. Optional Circuit continuity monitoring.

9. Optional soft start-up to limit start-up currents.
10. Optional system maintenance function scans system for potential failures when system is not in use.
11. Optional remote communications through RS-232, RS-422 or RS485 buss and ChromaSoft™ Remote Operator Interface.

Pipe Wall Sensing Panels

Pipe wall sensing panels use one temperature control point and one power control for each heat tracing circuit.

Typical Pipe Wall Sensing Control Panels Contain:

1. 3390 multi-loop temperature controller(s).
2. Solid State Relays or contactors.
3. Manual Disconnect Switch.
4. Cooling Fan.
5. Individual Ground Fault Circuit Breakers.
6. NEMA 4X, 7 and 12 enclosures available.
7. Optional current monitoring.
8. Optional Circuit continuity monitoring.
9. Optional soft start-up to limit start-up currents.
10. Optional system maintenance function scans system for potential failures when system is not in use.
11. Optional remote communications through RS-232, RS-422 or RS-485 buss and ChromaSoft™ Remote Operator Interface.

Chromalox®

Industrial Heat Tracing System Design

Connection Accessories Selection

The last step in designing a heat tracing system is to select the cable connection accessories. The accessories include power connection, splice and tee connection, and cable end sealing. The tables that follow detail the Chromalox connection accessory offering. Use these tables to select the proper accessories based on the area classification of your installation and your preference for DL Series or EL Series connection design. The illustration at right shows a typical heat trace circuit and how each connection accessory is used. Refer to PDS-PJ326 for DL Series and PDS-PJ321 for EL Series connection accessory details.

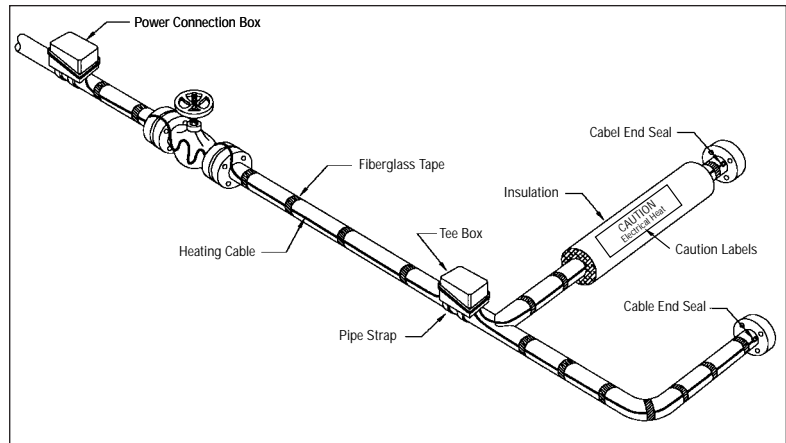

Table 14 — DL Series Connection Accessories

Connection Type	Designation	Used With	Number of Connections	NEMA Rating	Third Party Approvals		
					UL	CSA	FM
Power Connection (1), (3)	RTPC	SRL, SRM/E, CWM	3 Power	4X			
Power Connection with Signal Light (Signals Voltage Present) (1), (3)	RTPC-SL	SRL, SRM/E, CWM	3 Power	4X			
Splice & Tee Box (2), (3)	RTST	SRL, SRM/E, CWM	1 Splice or Tee	4X	Ordinary Areas	Ordinary Areas Class I, Div. 2 Groups A, B, C, D Class II, Div. 2 Groups F, G	Ordinary Areas Class I, Div. 2 Groups B, C, D Class II, Div. 2 Groups F, G Class III, Div. 2 Areas
End Seal (3)	RTES	SRL, SRM/E, CWM	1 End Seal	4X			
End Seal with Signal Light (2), (3)	RTST-SL	SRL, SRM/E, CWM	1 End Seal	4X			

Notes:

- (1) RTPC and RTPC-SL Models require use of a conduit hub CCH-2 and a pipe strap to fasten to the pipe.
- (2) RTST and RTST-SL Models require use of a pipe strap to fasten to the pipe.
- (3) All Models require use of a grommet to seal cable entry. See Table 16 to determine appropriate grommet size to use for each cable.

Table 15 — EL Series Connection Accessories

Connection Type	Designation	Used With	Number of Connections	NEMA Rating	Third Party Approvals		
					UL	CSA	FM
Junction Box Connection Kit (Self-Regulating Cable)	RT-JBC-1	SRL, SRM/E	1 Power	–		Ordinary Areas	
Junction Box Connection Kit (Constant Wattage Cable)	RT-JBC-2	CWM	1 Power	–		Ordinary Areas	
Junction Box (Order SLK-1 or SLK-2 signal light kit separately for voltage present signal light option)	JBLT	SRL, SRM/E, CWM	1 Power	4X		Ordinary Areas	
Explosion Proof Junction Box with Signal Light JBEP-SL 1 for 120 volts JBEP-SL 2 for 240 volts	JBEP-SL1 JBEP-SL2	SRL, SRM/E, CWM	1 Power	4X	Ordinary Areas	Ordinary Areas Class I, Div. 2 Groups A, B, C, D Class II, Div. 2 Groups F, G	Ordinary Areas Class I, Div. 2 Groups B, C, D Class II, Div. 2 Groups F, G Class III, Div. 2 Areas
Splice & Tee Kit	RT-RST	SRL	5 Splices	–		Ordinary Areas	
Splice & Tee Kit	RT-TST	CWM	5 Splices	–		Ordinary Areas	
End Seal Kit	RT-RES	SRL	5 End Seals	–		Ordinary Areas	
End Seal Kit	RT-TES	CWM	5 End Seals	–		Ordinary Areas	
Explosion Proof Junction Box	JBEP	SRL, SRM/E, CWM	1 Power	4X		Ordinary Areas Class I, Div. 2 Groups A, B, C, D Class II, Div. 2 Groups F, G	

Chromalox®

Industrial Heat Tracing System Design

Connection Accessories Selection

Use Table 16 to select the correct grommets for each of the DL series connections selected. Select grommets for each DL Series item, Power Connection, Splice & Tee or End Seal for the cable type used in each circuit. The grommet opening is sized to provide a water resistant seal for each cable type. Use Table 17 to select the proper fastening materials for the installation. Use Table 18 to determine the number of fastening kits to order per 100 feet of each pipe size in the installation.

Table 16 — DL Series Grommet Selection

Grommet Designation	Used With
GR1	SRL-C
GR2	SRL-CR, CT
GR3	CWM-C
GR4	CWM-CT
GR5	SRL-MC
GR6	SRL-MCR, MCT
GR7	SRM/E-C
GR8	SRM/E-CT

Table 17 — Attachment Accessories

Attachment Type	Designation	Installation Temperature		Quantity Per Kit
		Min.	Max.	
Fiberglass tape for fastening heating cable to pipe	FT-1	-40°F	365°F	1 roll - 3/4" x 180 ft.
Fiberglass tape for fastening heating cable to pipe	FT-2	-40°F	392°F	1 roll - 1/2" x 66 ft.
Cable ties for fastening heating cable to pipe	CT-100	-40°F	185°F	100
Aluminum tape for fastening heating cable to pipe	AT-1	-40°F	200°F	1 roll - 1-1/2" x 180 ft.
Pipe strap for mounting DL series boxes to 1/2" to 3/4" pipes	PS-1	-40°F	450°F	1
Pipe strap for mounting DL series boxes to 1" to 3-1/2" pipes	PS-3	-40°F	450°F	1
Pipe strap for mounting DL series boxes to 2-1/2" to 9" pipes	PS-10	-40°F	450°F	1
Mounting plate for installing DL series boxes on flat surfaces	MP-1	-40°F	450°F	1

Table 18 — Minimum Number of Kits required per 100 Feet of Pipe Length

Size	CT-100	FT-1	FT-2
1/2"	1	0.31	0.51
3/4"	1	0.39	0.64
1"	1	0.48	0.79
1-1/4"	1	0.61	1.00
1-1/2"	1	0.70	1.15
2"	1	0.87	1.42
2-1/2"	1	1.10	1.80
3"	1	1.30	2.13
3-1/2"	2	1.50	2.45
4"	2	1.70	2.78
5"	2	2.00	3.27
6"	2	2.40	3.93
8"	3	3.20	5.24
10"	3	3.90	6.38
12"	4	4.70	7.69
14"	4	5.10	8.35
16"	4	5.90	9.65
18"	5	6.60	10.80
20"	5	7.30	11.95
24"	6	8.80	14.40

Note — If using Aluminum Tape Kit AT-1, plan to use 1 foot of tape for each foot of heating cable.

Chromalox®

Industrial Heat Tracing

Mineral Insulated Cable

MI Heating Cable Assemblies

MI Mineral Insulated Heating Cable is ideal for rugged industrial pipe tracing applications. Process temperatures up to 900°F can be maintained. Any voltage up to 600V may be used. At lower temperatures, MI cable sets can be designed to provide up to 50 W/Ft.

Its tough outer sheath of Alloy 825 resists damage during installation, and provides a reliable electrical ground for safe operation. The fully annealed sheath is flexible, allowing field installation on most any equipment. The alloy sheath is very chemical resistant and can be used in a large number of corrosive environments. MI cable will not burn or support combustion. All materials are inorganic, and will not deteriorate with age.

MI cable is made with either one or two conductors, insulated with compacted magnesium oxide for high dielectric strength. Cable assemblies are custom made at the factory to meet your specific needs. Basic heater designs are shown below.

Mineral Insulated cables can be manufactured into the heater designs shown on this page. The standard cold lead is 12 AWG Alloy 825 sheathed MI power cable. The standard cold lead length is 3 feet unless otherwise specified (2 Ft. is the minimum length). The cold lead is brazed to the cable, forming a reliable liquid tight seal.

Use the information and procedure on the following pages to design and specify MI units to meet your specific requirements. Contact your Local Chromalox Sales Office for additional assistance or information.

Basic Heater Designs

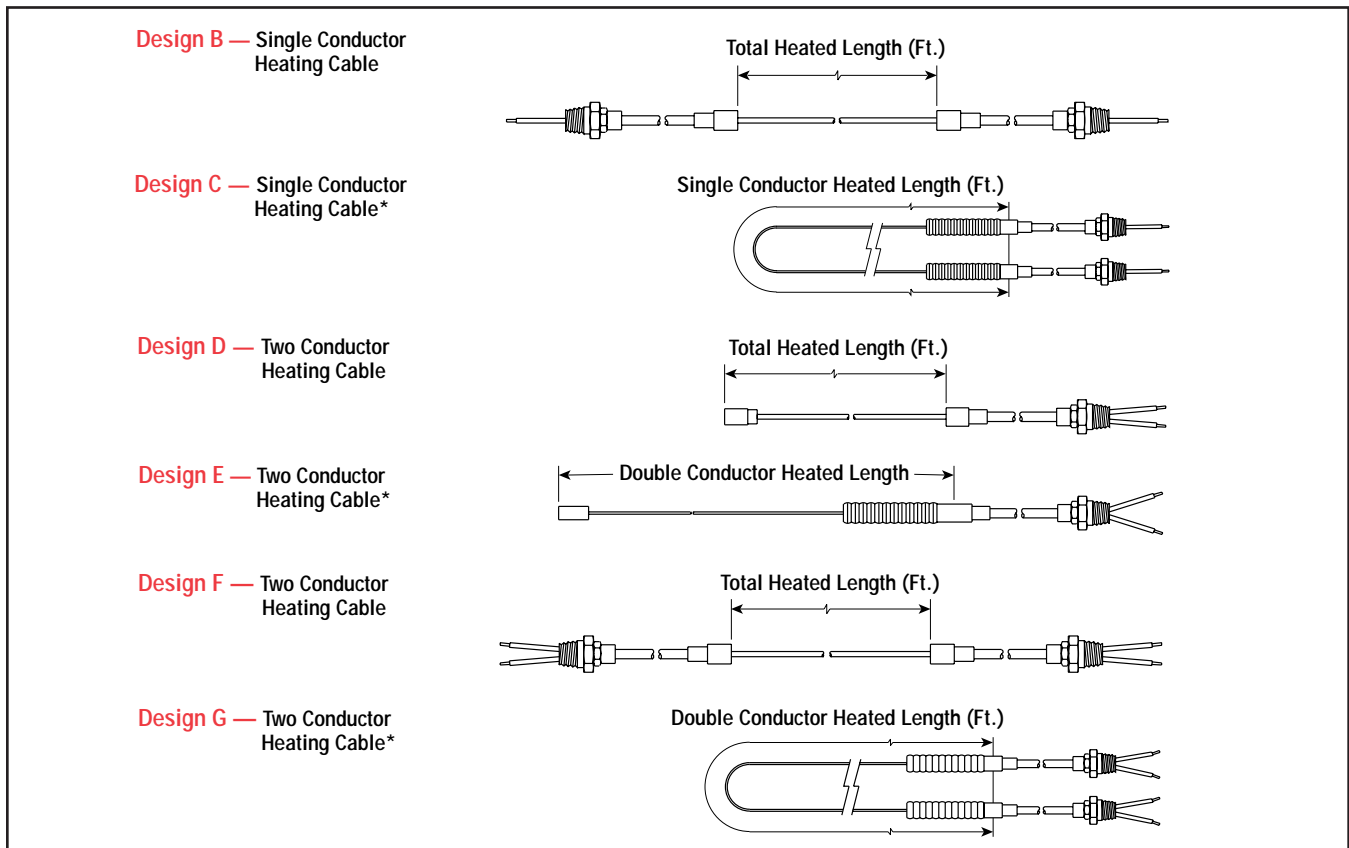

*For use when maintenance temperature exceeds 400°F.

Chromalox®

Industrial Heat Tracing Mineral Insulated Cable

MI Heating Designs for Pipes

Step 1 — Heater Design

Determine heater design to use. Design D is usually the most convenient design using two conductor cable. Design B is usually preferred for single conductor cable.

Step 2 — Heat loss in Watts per foot (W/Ft.)

Use the value calculated in thermal design section, Step 6.

Step 3 — Cable length (L)

Use the length calculated in cable selection section, Step 8.

Step 4 — Supply Voltage available (V)

Determine what Voltage is available. When different Voltages are available, it provides multiple cable choices which may result in a more accurate design.

Step 5 — Calculate Resistance per Foot (R/Ft.)

$$R/Ft = \frac{V^2}{W/Ft \times L^2}$$

Step 6 — Select the proper R/Ft. rating

Choose a cable having equal or the next lower resistance per foot value from Table 19. Adjust the resistance of the cable if indicated.

Step 7 — Calculate the actual Watts per foot (W/Ft.) and the total wattage (W), using the cable R/Ft.

$$W/Ft = \frac{V^2}{R/Ft \times L^2}$$

$$W = W/Ft \times L^2$$

Step 8 — Determine the current draw (I)

$$I = \frac{W}{V}$$

Step 9 — Convert design to a model number

1. Try design "D"

2. Q = 6.9 W/Ft.

3. L = 107 Ft.

4. V = 120 Volts

5.

$$R/Ft = \frac{(120)^2}{(6.9) \times (107)^2} = 0.182$$

6. From Table 19, Choose B060

7.

$$W/Ft = \frac{(120)^2}{(0.182) \times (107)^2} = 6.9$$

$$W = 6.9 \times 107 = 738.3$$

8.

$$I = \frac{738.3}{120} = 6.15$$

9. D/B060/107Ft/738W/120V/36"12

Model Number Example

D / B060 / 107 Ft / 738W / 120V / 36" / 12

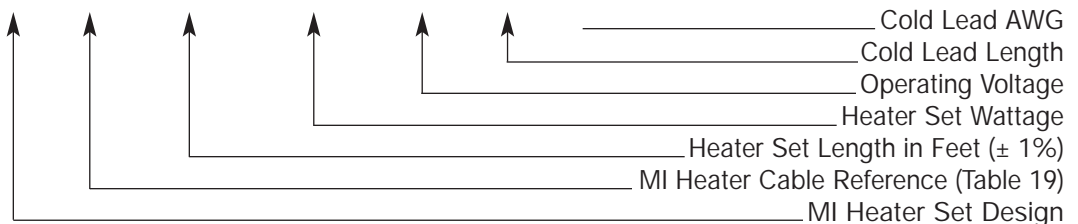

Table 19 — MI Cable Selection

MI Cable Reference	Nominal Cable Resistance 25°C (Ohms/Ft.)	Approx. Cable Diameter (In.)	Maximum recommended W/Ft. of cable when strapped to an insulated metal pipe at:				
			40°F	100°F	200°F	300°F	400°F
Single Conductor Cable — Alloy Sheath — 600 Volt Max.							
K009*	0.029	0.187	46	40	28	17	10
K012*	0.036	0.187	46	40	28	17	10
K017	0.052	0.187	46	40	28	17	10
K025	0.076	0.187	46	40	28	17	10
K030	0.091	0.187	46	40	28	17	10
K043	0.131	0.187	46	40	28	17	10
K060	0.182	0.187	46	40	28	17	10
K095	0.289	0.187	46	40	28	17	10
K130	0.396	0.187	46	40	28	17	10
K185	0.563	0.187	46	40	28	17	10
K260	0.792	0.187	46	40	28	17	10
K330	1.00	0.187	46	40	28	17	10
K470	1.43	0.187	46	40	28	17	10
K655	2.00	0.187	46	40	28	17	10
K935	2.85	0.187	46	40	28	17	10
K1315	4.00	0.187	46	40	28	17	10
Two Conductor Cable — Alloy Sheath — 300 Volt Max.							
H011*	0.033	0.187	46	40	28	17	10
H013*	0.039	0.187	46	40	28	17	10
H069	0.210	0.187	46	40	28	17	10
H100	0.300	0.187	46	40	28	17	10
H125	0.380	0.187	46	40	28	17	10
H195	0.590	0.187	46	40	28	17	10
H255	0.780	0.187	46	40	28	17	10
H400	1.22	0.187	46	40	28	17	10
H550	1.68	0.187	46	40	28	17	10
H670	2.04	0.187	46	40	28	17	10
H990	3.02	0.187	46	40	28	17	10
H1400	4.27	0.187	46	40	28	17	10
H1950	5.94	0.187	46	40	28	17	10
H2850	8.69	0.187	46	40	28	17	10
H3600	10.97	0.187	46	40	28	17	10
H5910	18.01	0.187	46	40	28	17	10
Two Conductor Cable — Alloy Sheath — 600 Volt Max.							
B0069*	0.021	0.312	50	50	41	28	17
B014*	0.042	0.312	50	50	41	28	17
B023	0.070	0.312	50	50	41	28	17
B034	0.103	0.312	50	50	41	28	17
B050	0.152	0.312	50	50	41	28	17
B060	0.182	0.312	50	50	41	28	17
B085	0.259	0.312	50	50	41	28	17
B120	0.365	0.312	50	50	41	28	17
B190	0.579	0.312	50	50	41	28	17
B260	0.800	0.312	50	50	41	28	17
B370	1.12	0.312	50	50	41	28	17
B520	1.58	0.312	50	50	41	28	17
B660	2.00	0.312	50	50	41	28	17
B940	2.87	0.312	50	50	41	28	17
B1310	4.00	0.312	50	50	41	28	17
B1870	5.70	0.312	50	50	41	28	17

*Multiply resistance by 1.15 for temperatures up to 300°F. Multiply by 1.23 for maintenance temperatures over 300°F.

Chromalox®

Industrial Heat Tracing

Typical Installation Details

Check each MI cable with a 500V insulation tester. A reading of at least 20mΩ should be recorded between the conductor(s) and cable sheath. Check MI cable set before, during and after installation. Lower values may occur during inclement weather. Store MI sets in a dry location until ready for installation.

Temporarily position MI on pipe and equipment to insure proper distribution. Leave a loop of cable at heat sinks such as valves, pipe supports and flange sets. Use stainless steel wire or bands to secure cable.

Permanently secure non-heating power lead. Bend cable 3" away from all splices and fittings. Evenly position cable along pipe and secure at 18" (nom) intervals. Always observe 7x minimum bend radius.

Thermal insulation suitable for the application should be installed in accordance to the manufacturer's instructions. Do not allow heating cables to be embedded in the thermal insulation.

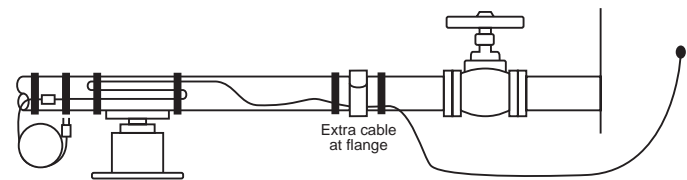
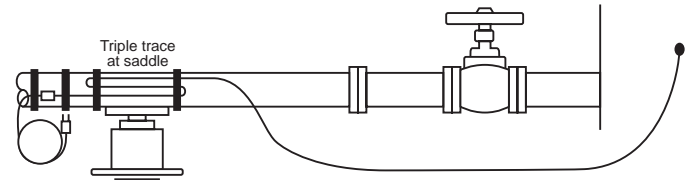
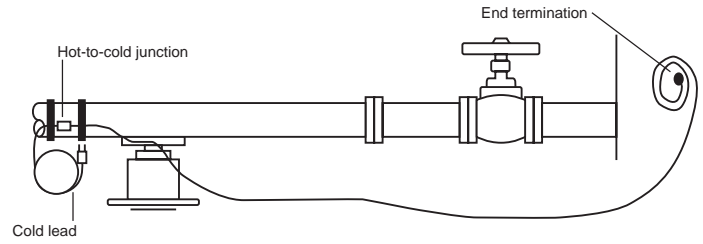

Flange Detail

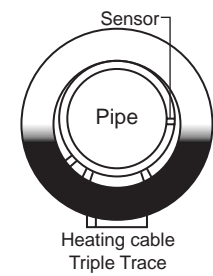
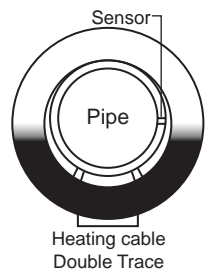
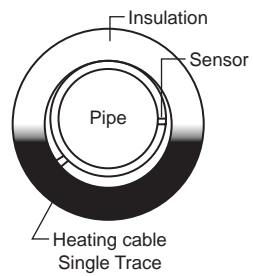
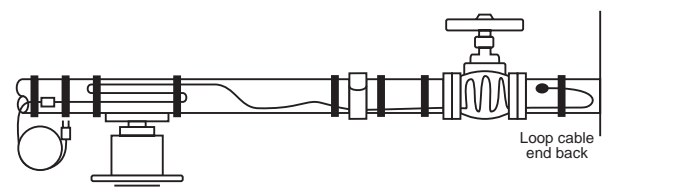
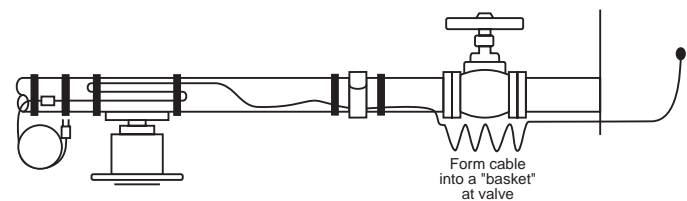
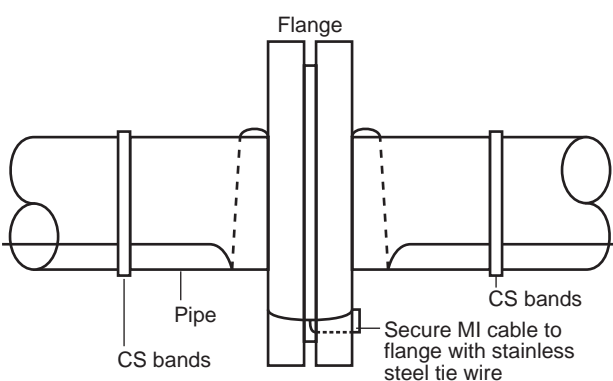

Chromalox®

GENERAL INFORMATION

To insure the best possible service when obtaining sales and application assistance, quotations or placing an order, contact your nearest Chromalox sales and application engineering office listed on the back cover of this catalog.

Chromalox warrants only that the Products and parts manufactured by Chromalox, when shipped, and the work performed by Chromalox when performed, will meet all applicable specification and other specific product and work requirements (including those of performance), if any, and will be free from defects in material and workmanship under normal conditions of use. All claims for defective or nonconforming (both hereinafter called defective) Products, parts or work under this warranty must be made in writing immediately upon discovery, and in any event, within one (1) year from delivery, provided, however all claims for defective Products and parts must be made in writing no later than eighteen (18) months after shipment by Chromalox. Defective and nonconforming items must be held for Chromalox's inspections and returned to the original f.o.b. point upon request. THE FOREGOING IS EXPRESSLY IN LIEU OF ALL OTHER WARRANTIES WHATSOEVER, EXPRESS, IMPLIED AND STATUTORY, INCLUDING, WITHOUT LIMITATION, THE IMPLIED WARRANTIES OF MERCHANTABILITY AND FITNESS FOR A PARTICULAR PURPOSE.

Notwithstanding the provisions of this WARRANTY AND LIMITATION Clause, it is specifically understood that Products and parts not manufactured and work not performed by Chromalox are warranted only to the extent and in the manner that the same are warranted to Chromalox by Chromalox's vendors, and then only to the extent that Chromalox is reasonably able to enforce such warranty, it being understood Chromalox shall have no obligation to initiate litigation unless Buyer undertakes to pay all cost and expenses therefor, including but not limited to attorney's fees, and indemnifies Chromalox against any liability to Chromalox's vendors arising out of such litigation.

Upon Buyer's submission of a claim as provided above and its substantiation, Chromalox shall at its option either (i) repair or replace its Products, parts or work at the original f.o.b. point of delivery or (ii) refund an equitable portion of the purchase price.

THE FOREGOING IS CHROMALOX'S ONLY OBLIGATION AND BUYER'S EXCLUSIVE REMEDY FOR BREACH OF WARRANTY, AND IS BUYER'S EXCLUSIVE REMEDY AGAINST CHROMALOX FOR ALL CLAIMS ARISING HEREUNDER OR RELATING HERETO WHETHER SUCH CLAIMS ARE BASED ON BREACH OF CONTRACT, TORT (INCLUDING NEGLIGENCE AND STRICT LIABILITY) OR OTHER THEORIES, BUYER'S FAILURE TO SUBMIT A CLAIM AS PROVIDED ABOVE SHALL SPECIFICALLY WAIVE ALL CLAIMS FOR DAMAGES OR OTHER RELIEF, INCLUDING BUT NOT LIMITED TO CLAIMS BASED ON LATENT DEFECTS. IN NO EVENT SHALL BUYER BE ENTITLED TO INCIDENTAL OR CONSEQUENTIAL DAMAGES AND BUYER SHALL HOLD CHROMALOX HARMLESS THEREFROM. ANY ACTION BY BUYER ARISING HEREUNDER OR RELATING HERETO, WHETHER BASED ON BREACH OF CONTRACT, TORT (INCLUDING NEGLIGENCE AND STRICT LIABILITY) OR OTHER THEORIES, MUST BE COMMENCED WITHIN ONE (1) YEAR AFTER THE DATE OF SHIPMENT OR IT SHALL BE BARRED.

W2008M

The facts and the recommendations made in this publication are based on our own research and the research of others, and are believed to be accurate.

We cannot anticipate all conditions under which this information and our products, or the products of other manufacturers in combination with our products, may be used. We accept no responsibility for results obtained by the application of this information or the safety and suitability of our products, either alone or in combination with other products. Users are advised to make their own tests to determine the safety and suitability of each such product combination for their own purposes.

Chromalox Sales & Application Engineering Offices

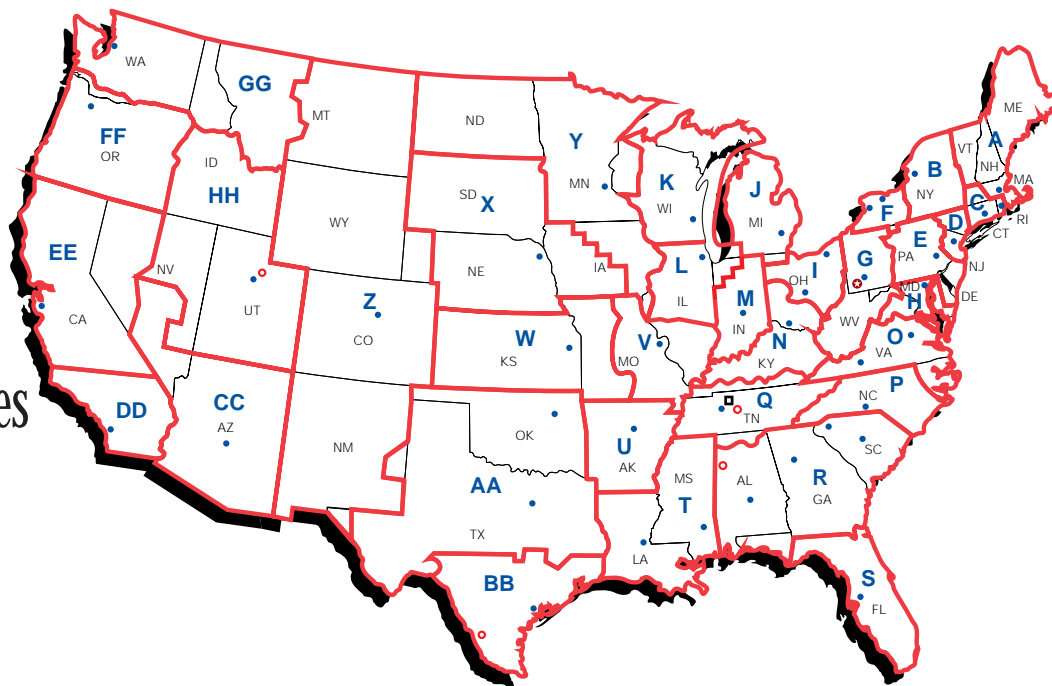

- ★ World Headquarters
- Nashville Distribution Center
- Manufacturing Locations
- Sales Offices

- | | | | | |
|---|--|--|---|--|
| <p>A LEO PELKUS, INC.
Wellesley Hills, MA 02481
(Boston Area)
170 Worcester Street
P.O. Box 81349
(781) 235-8040
Fax: (781) 239-0631</p> <p>B LIBERTY ELECTRIC SALES, INC.
East Syracuse, NY 13057
6602 Joy Road
1-800-777-2345
(315) 437-8100
Fax: (315) 437-0681</p> <p>C DITTMAN & GREER, INC.
Middletown, CT 06457
125 Coe Avenue
(860) 347-4655
Fax: (860) 346-4752</p> <p>Providence, RI
(401) 751-5508</p> <p>D FABER ASSOCIATES
Clifton, NJ 07015
1111 Paulison Avenue
P.O. Box 2000
NJ (973) 546-7900
Central NJ (732) 572-3434
NY (212) 947-4100
Fax: (973) 546-9337</p> <p>E CHROMALOX SALES OFFICE
(Philadelphia Area)
(610) 647-7880
Fax: (610) 647-7889</p> <p>F NIAGARA ELECTRIC SALES CO.
Buffalo, NY 14218
3280 South Park Avenue
(716) 825-3100
Fax: (716) 825-0331</p> <p>NIAGARA ELECTRIC SALES CO.
Rochester, NY 14623
3029 Brighton-Henrietta T.L. Rd.
(716) 272-9150
Fax: (716) 272-0169</p> <p>G CHROMALOX SALES OFFICE
Pittsburgh, PA 15238
701 Alpha Drive
(412) 242-0400
Fax: (412) 242-5219</p> | <p>H FABER-RENOFF, INC.
Sykesville, MD 21784
5339-A Enterprise Street
(410) 781-7300
Fax: (410) 781-7304</p> <p>I ANDERSON-BOLDS, INC.
Cleveland, OH 44122
24050 Commerce Park Rd.
(216) 360-9800
Fax: (216) 360-0425</p> <p>ANDERSON-BOLDS, INC.
Columbus, OH 43085
6463 Proprietors Road
P.O. Box 123
(614) 885-3933
Fax: (614) 885-5794</p> <p>J DAVE RAY & ASSOCIATES
Royal Oak, MI 48073-1086
2603 Parmenter Blvd.
(248) 280-0000
Fax: (248) 280-0998</p> <p>K GORDON HATCH CO., INC.
Germantown, WI 53022
P.O. Box 854
N118 W18252 Bunsen Dr.
1-800-925-4328
(414) 253-4800
Fax: (414) 253-4180</p> <p>L TOUROUTELO CO.
Elk Grove Village, IL 60007
(Chicago Area)
1713 Elmhurst Road
1-800-643-4328
(847) 290-6000
Fax: (847) 290-6070
E-mail: sales@tourtelot.com</p> <p>M COUCHMAN-CONANT, INC.
Noblesville, IN 46060
(Indianapolis Area)
15400 Herriman Blvd.
1-800-825-9890
(317) 773-0500
Fax: (317) 773-6444</p> <p>N CHROMALOX SALES OFFICE
(Cincinnati Area)
(513) 874-6612
Fax: (513) 874-1575</p> <p>O DOMINION TECHNICAL SALES, INC.
Richmond, VA 23294
2510 Waco Street
(804) 755-6007
Fax: (804) 755-7443</p> | <p>DOMINION TECHNICAL SALES, INC.
Roanoke, VA 24037
P.O. Box 13854
1-800-851-4328</p> <p>P CHROMALOX SALES OFFICE
Charlotte, NC 28270
9301-I Monroe Road
(704) 841-8727
Fax: (704) 841-0797</p> <p>Q APPLIED THERMAL SYSTEMS, INC.
Chattanooga, TN 37422
3903 Volunteer Drive
P.O. Box 23055
1-800-733-8826
(423) 899-9664
Fax: (423) 899-9725</p> <p>APPLIED THERMAL SYSTEMS, INC.
Nashville, TN 37210
1451 Elm Hill Pike — Suite 208
P.O. Box 101493
(615) 366-0221
Fax: (615) 366-0290</p> <p>R APPLEBEE-CHURCH, INC.
Atlanta (Norcross), GA 30071
3120-H100 Medlock Bridge Road
(770) 368-0030
Fax: (770) 449-8489</p> <p>APPLEBEE-CHURCH, INC.
Birmingham, AL 35244
2018 Russett Meadow Ct.
(205) 879-4417 Inside
(205) 428-3171 Outside
Fax: (205) 428-2582</p> <p>APPLEBEE-CHURCH, INC.
Columbia, SC 29212
(803) 407-2520
Fax: (803) 407-2502</p> <p>APPLEBEE-CHURCH, INC.
Greenville, SC 29680
(864) 627-4328
Fax: (864) 297-9099</p> <p>S J.J. GALLEHER CO.
Clearwater, FL 33756
1170 Gould St.
(813) 461-7706
Fax: (813) 446-4502</p> <p>T ROSS & PETHTEL, INC.
Baton Rouge, LA 70816
10905 North Harrell's Ferry Rd.
(225) 273-2202
Fax: (225) 273-2297</p> | <p>ROSS & PETHTEL, INC.
Jackson, MS 39205
(601) 922-8487</p> <p>U CARLTON CO.
Little Rock, AR 72203
P.O. Box 3433
(501) 664-6324
Fax: (501) 664-7137</p> <p>V CARLTON CO.
St. Louis, MO 63126
9291 Watson Road
(314) 968-3850
Fax: (314) 968-1507</p> <p>W CARLTON CO.
Overland Park, KS 66207
(Kansas City Area)
4421 Indian Creek Parkway
(913) 642-6655
Fax: (913) 642-1576</p> <p>X VOLCO CO.
Omaha, NE 68144
1258 South 119th Court
(402) 330-6700
Fax: (402) 330-6703</p> <p>Y VOLCO CO.
Minneapolis, MN 55426
7505 Hwy. #7
P.O. Box 26363
(612) 933-6631
Fax: (612) 933-6541</p> <p>Z E & M SALES, INC.
Littleton, CO 80127
10720 Bradford Road
Suite 100
(303) 979-5000
Fax: (303) 979-8200
Outside Colorado: 1-800-525-9577</p> <p>AA DON SHUHART CO.
Dallas, TX 75238
11010 Switzer Avenue, Suite 107
(214) 349-6000
Fax: (214) 349-9342</p> <p>DON SHUHART CO.
Tulsa, OK 74105
2241 East Skelly Drive
(918) 747-4136
Fax: (918) 492-3938</p> <p>BB CHROMALOX SALES OFFICE
Houston, TX 77060
600 Kenrick, B-12
(281) 847-1868
Fax: (281) 847-0354</p> | <p>For Heat Tracing Products Only:
WILSHER CO.
Houston, TX 77055
1823 Antoine Drive
(713) 683-6826
Fax: (713) 683-8281</p> <p>CC VORDOS & ASSOCIATES
Scottsdale, AZ 85260
9130 East Pine Valley Road
1-800-346-8715
(602) 991-0999
Fax: (602) 991-9393</p> <p>DD CHROMALOX SALES OFFICE
Southern California
(Los Angeles Area)
1-800-634-5573
(562) 945-8303
Fax: (562) 945-8308</p> <p>EE CHROMALOX SALES OFFICE
Northern California
(San Francisco Area)
1-800-634-5573
(408) 946-1404
Fax: (408) 946-1694</p> <p>FF CHROMALOX SALES OFFICE
Portland, OR 97219
1-800-634-5573
(503) 246-3366
Fax: (503) 245-7632</p> <p>GG CHROMALOX SALES OFFICE
Bellevue, WA 98005
(Seattle Area)
1850 130th Ave. N.E. #1
(425) 885-0372
Fax: (425) 885-5579</p> <p>Alaska: 1-800-634-5573</p> <p>HH VORDOS & ASSOCIATES
Salt Lake City, UT 84111
353 East 400 South, Suite 202
1-800-346-8715
(801) 521-2111
Fax: (801) 521-8833</p> |
|---|--|--|---|--|

Chromalox®
First Name in Electric Heat

www.chromalox.com

701 ALPHA DRIVE
PITTSBURGH, PA 15238
Phone: (412) 967-3800 Fax: (412) 967-5148
CHROMALOX SURFACE HEATING GROUP
600 RIDGELY ROAD
MURFREESBORO, TN 37129
Phone: (615) 848-2565 Fax: (615) 848-2181

